



KOREAN Manufacturer

Flow Line Equipment

Forging Products

Treating Iron



▶ CONTENTS



SMI Profile



History and Vision



Products



Sales Records



Certificates



Facilities and Equipments



Exhibitions & Annual Company Events

► SMI PROFILE

Plant I – Casting Factory
Gumi-si, Korea



**Plant II – Manufacturing,
Head Office**
Chilgok-gun, Korea



Plant III – Pup Joint Factory
Chilgok-gun, Korea



SMI is
Korean leading manufacturer
of flow line equipment

CEO

Sun Bong, Bae

Establishment

Sep 1, 1998

Employees

94

Business Scope

Oil & Gas Industry
Casting and Machining

MANAGEMENT POLICY



HISTORY OF SMI

1990s

- **1998.09** Establishment / Registered on vendor of Hyundai Heavy Industry

2000s

- **2002.10** Certified with the ISO 9001
- **2005.03** Expanded Plant II / Start Oil & Gas Industry
- **2008.11** Obtained a patent on a frame structure of water cooling system

2010s

- **2010.03** Obtained Certifications of API MONOGRAM LISENCE. (6A,6D,16C)
- **2011.01** Registered on vendor of National Iranian Drilling Company
- **2012.12** Achieved \$5Milion export / Received a presidential citation
- **2013.08** Registered on vendor of Peru Public Procurement Service
- **2014.12** Achieved \$10Milion export

2015s

- **2015.06** Registered on vendor of Samsung Heavy Industry and DSME
- **2015.09** Obtained two patents on a pressure test equipment
- **2016~** Governmental R&D Projects : High pressure Diverter / Hub Clamps / Wash pipe

VISION 2020

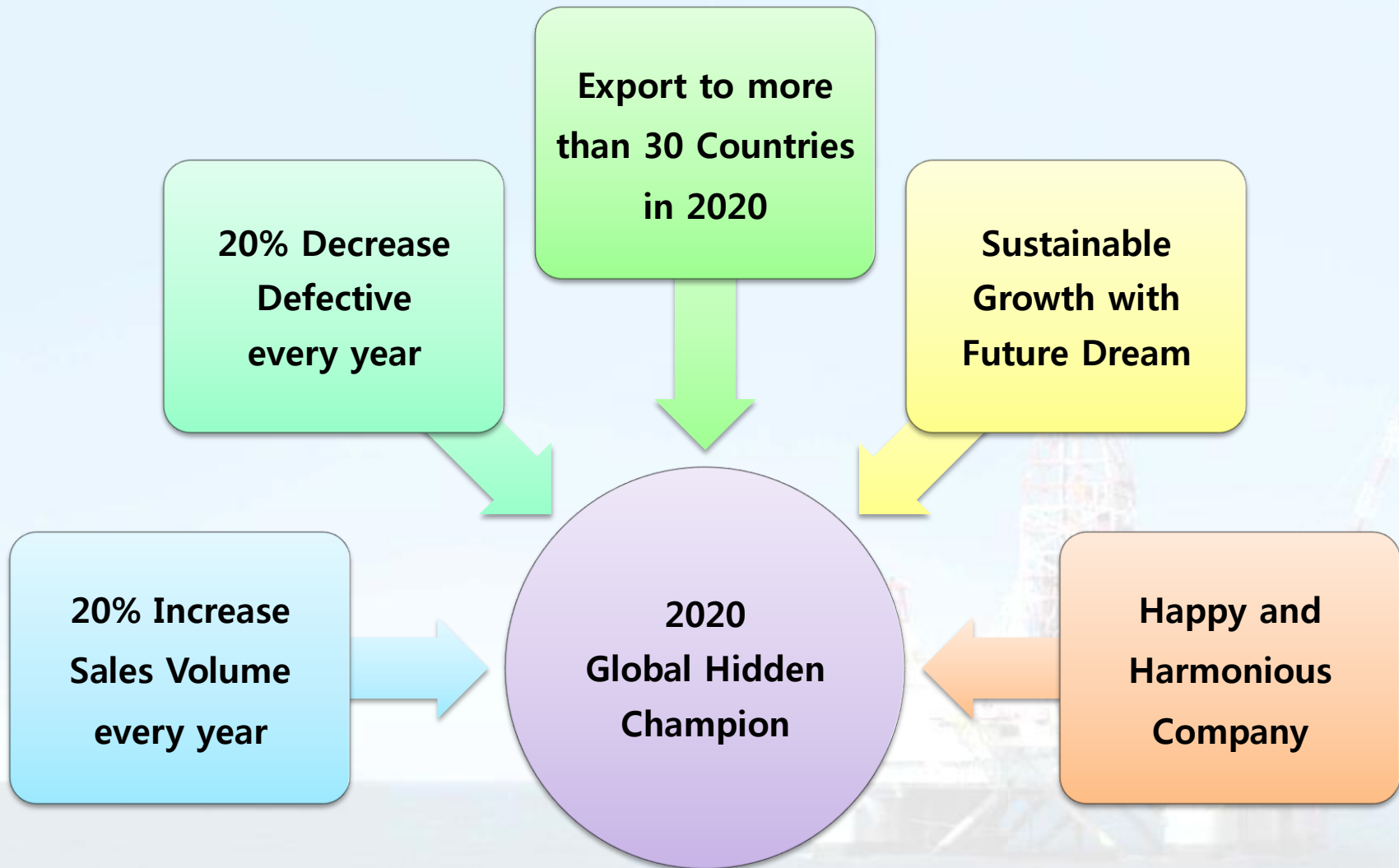

▶ PRODUCTS

Onshore Application



Offshore Application

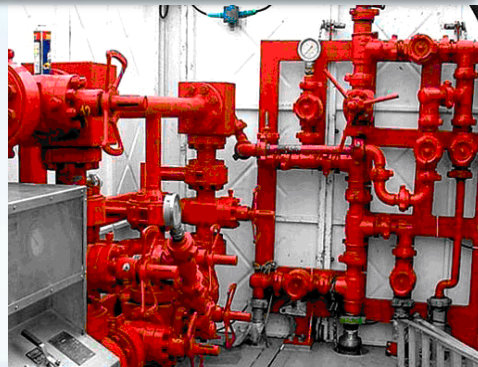

- Flow line equipment
- Choke and kill line
- High pressure cement line
- High pressure mud line
- Fracturing unit
- Wellhead and well testing
- Crude oil and fuel oil
- Gas and compressed air
- Sea water and pure water

Manifold

Photo

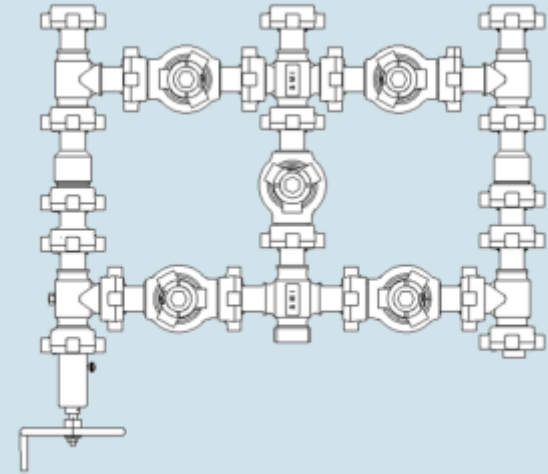
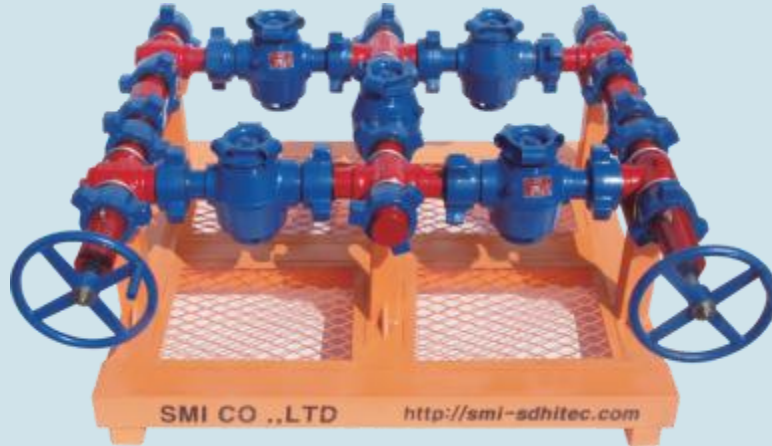

Property

SMI Manifolds are designed and manufactured to meet customer's requirements such as 5,7,8 or 9 Valves Manifold.

SMI Product lines offer wide range of Hammer Union End equipments

- Plug Valves, Adj. Chokes, Pos. Chokes, Tees, Crosses, Laterals , Crossovers etc.
- API 6A flanged ends equipments.

Mud & Cement Manifold System Production Progress

Drawing

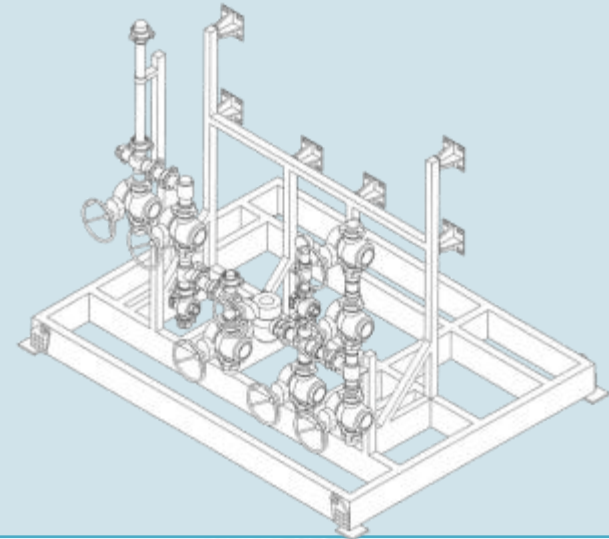
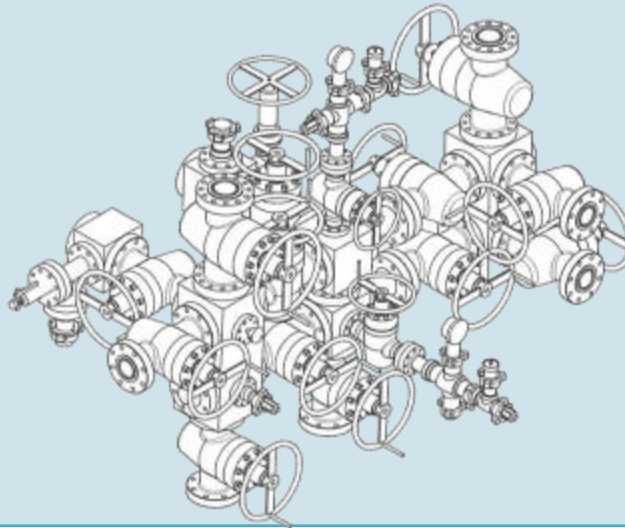

Property

Used on Drilling rigs such as Drill-Ship, and Semi-Rig.

- TF Team at Samsung Heavy Industry requested for production on 2014.12.23.
- The design was completed, then submitted reports and drawings on 2015.08.18
- We expect approximately 30% of cost saving.
- SMI can assemble complex solutions as per customer's requirement.

Plug Valve

Photo





Property



2 x 1, 2 x 2 and 3 x 3 Plug Valve .
 Standard Service is used up to 15,000psi and tested at 22,500psi.
 (H2s Service is used up to 10,000psi and tested at 15,000 psi)

Rugged Connection with Forged Alloy Steel Body.
 Reliable Performance at high Working pressure.
 Valve Parts are interchangeable with most of major brand product.

Choke Valve

| | | |
|----------|---|---|
| Photo |  <p data-bbox="568 796 950 843">Adjustable Choke</p> |  <p data-bbox="1340 796 1657 843">Positive Choke</p> |
| Property | <p data-bbox="394 905 1785 1100">2" Fig1502 MxF with 3/4", 1" Orifice and 3" Fig1502 MxF with 2" Orifice. 2" and 3" Fig 1502 with Adjustable type and Positive type. Standard Service is used up to 15,000psi and tested at 22,500psi. (H2s Service is used up to 10,000psi and tested at 15,000 psi)</p> <p data-bbox="394 1158 1715 1253">Forged Alloy Steel body, Stainless steel and tungsten carbide parts. Parts are interchangeable with major brands.</p> | |

Cheke Valve

| | | |
|-----------------|--|--|
| <p>Photo</p> |  <p style="text-align: center;">2" Check Valve Swing Type Composition</p> |  <p style="text-align: center;">2" Check Valve Flapper Type Composition</p> |
| <p>Property</p> | <p>There are two types of 2" Fig 1502 Check Valve such as Swing Type and Flapper Type.</p> <p>For 2" and 3" Fig 1502, Standard service is used up to 15,000psi and tested at 22,500psi. (H2S service is used up to 10,000psi and tested at 15,000psi)</p> <p>Valve Parts are interchangeable with most major brands.</p> | |

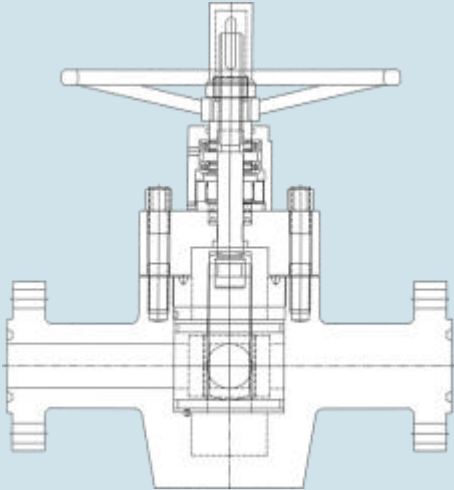

Gate Valve

| | | |
|-----------------|---|---|
| <p>Photo</p> |  |  |
| <p>Property</p> | <p>Standard Service is used up to 15,000psi and tested at 22,500psi. (H2s Service is used up to 10,000psi and tested at 15,000 psi)</p> <p>Specification for Wellhead and Christmas Tree Equipment</p> <p>Suitable for variety of high pressure applications such as mud manifold, well testing and etc.</p> | |

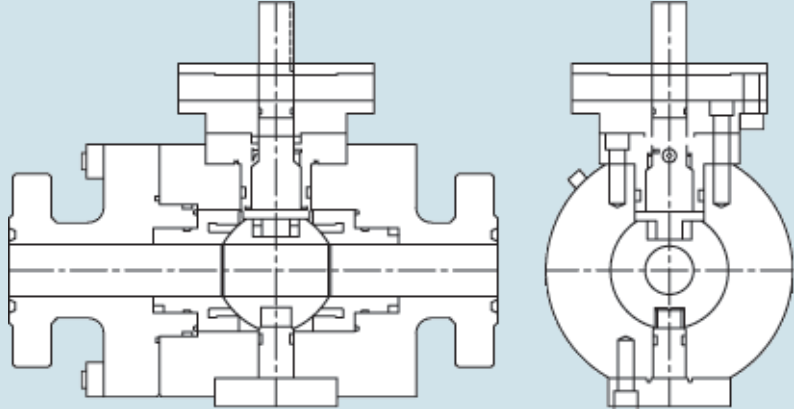

Trunnion Ball Valve

| | | |
|-----------------|---|---|
| <p>Photo</p> |  |  |
| <p>Property</p> | <p>API 6A Trunnion mounted ball valves made with AISI 4130/4140.</p> <p>1 ¹³/₁₆" ~ 3 ¹/₈" API 5000psi and 10000psi are available.</p> <p>Lip seals for high pressure sealing.</p> <p>Metal rings for efficient fire safety.</p> | |





Swivel Joint

| | | | |
|-----------------|---|---|--|
| <p>Photo</p> |  <p>Style #10</p> |  <p>Style #30</p> |  <p>Style #50</p> |
| <p>Property</p> | <p>Forged Alloy Steel Elbows with Heat Treatment. Standard Service is used up to 15,000psi and tested at 22,500psi. (H2s Service is used up to 10,000psi and tested at 15,000 psi)</p> <p>All Styles are available in nominal size 2" and 3" with 1502 Union Ends. Each Product is serialized and pressure tested.</p> | | |

Pup Joint

| | | |
|----------|--|---|
| Photo |  <p>2"-Fig 1502 2 ft</p> |  <p>2"-Fig 1502 2 ft</p> |
| Property | <p>Available for 2" and 3" of nominal pipe sizes for CWP 15,000psi.</p> <p>There are NPS type and Integral type and the length can be changed as customer's requirements</p> <p>Cementing and circulating hose loop can be assembled with Swivel Joint & Pup Joint</p> | |

Fittings

| | | | | |
|----------|---|-------|---|---------|
| Photo |  | Elbow |  | Tee |
| |  | Cross |  | Adapter |
| Property | <p>SMI Fittings are available 2" to 3" nominal pipe sizes. STD service CWP 15000psi/ TP 22500 psi H2S service CWP 10000psi/ TP 15000psi.</p> <p>Wide range of fittings from Elbow to Swages with Fig 1502 Union Ends.</p> | | | |

Studded Block (Tee, Cross)

Photo

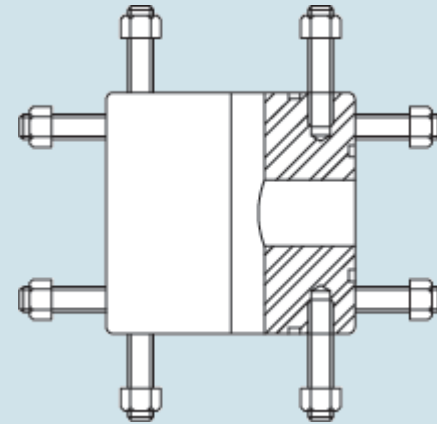

Property

Standard Service is used up to 15,000psi and tested at 22,500psi.
(H2s Service is used up to 10,000psi and tested at 15,000 psi)

Specification for Wellhead and Christmas Tree Equipment

Suitable for variety of high pressure applications such as mud manifold, well testing and etc.

Hammer Union





| | | |
|----------|--|---|
| Photo |  |  |
| |  |  |
| Property | <p>Manufactured from forged steel to meet specific pressure ratings. Available all size and figure / Threaded and Butt Weld All H2S Service parts conform to the latest NACE specifications.</p> <p>SMI Hammer unions are fully interchangeable with WECO union.</p> | |

Fig 100
Fig 200

Fig 400
Fig 602

Fig 1002
Fig 1502

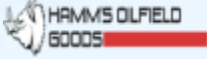

Fig 2202

SALES STATUS

(UNIT : USD 1000)

| No. | Category | Market | 2011 | 2012 | 2013 | 2014 | 2015 | 2020 Goal | Remark |
|-------|------------------------|----------|-------|--------|--------|--------|--------|-----------|--------|
| 1 | Flow Line Equipment | Overseas | 1,578 | 11,650 | 13,450 | 17,758 | 10,335 | 50,000 | 60% |
| | | Domestic | - | 50 | 150 | 867 | 1,835 | 8,000 | |
| 2 | Electronic Motor Parts | Domestic | 8,285 | 9,650 | 8,740 | 8,951 | 8,543 | 12,000 | 40% |
| Total | | | 9,863 | 21,350 | 22,340 | 27,576 | 20,713 | 70,000 | 100% |

SALES REFERENCE

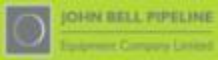
| Client | Country | Item | Year |
|--|------------|--|-----------|
|  American Block | USA | Plug Valve, Choke Valve, Swivel Joint, Hammer Union, Union Fittings and etc. | 2010~2016 |
|  Chem Oil Products | USA | Plug Valve, Choke Valve, Swivel Joint, Hammer Union, Union Fittings and etc. | 2010~2016 |
|  EZ FLOW Control Inc. | USA | Plug Valve, Choke Valve, Swivel Joint, Hammer Union, Union Fittings and etc. | 2012~2016 |
|  ON TOP OF YOUR NEEDS MOUNTAIN SUPPLY & SERVICE | USA | Plug Valve, Choke Valve, Swivel Joint, Hammer Union, Union Fittings and etc. | 2013~2016 |
|  HAMM'S OILFIELD 6005 | USA | Plug Valve, Choke Valve, Swivel Joint, Hammer Union, Union Fittings and etc. | 2012~2016 |
|  VALVES & FITTINGS, INC. | USA | Plug Valve, Ball Valve, Swivel Joint, Hammer Union, Union Fittings and etc. | 2011~2016 |
|  DIMACC | Ecuador | Plug Valve, Choke Valve, Swivel Joint, Hammer Union, Union Fittings and etc. | 2012~2016 |
|  IOT-Dosco B.V | Netherland | Plug Valve, Swivel Joint, Pup Joint and etc. | 2015~2016 |
|  JOHN BELL PIPELINE Equipment Company Limited | UK | Hammer Union, Union Fittings and etc. | 2015~2016 |
|  MANSFIELD SYSTEMS INTERNATIONAL | UAE | Choke Valve, Swivel Joint, Hammer Union, Union Fittings and etc. | 2013~2016 |
|  GENERAL PETROLEUM OIL TOOLS | Australia | Plug Valve, Choke Valve, Ball Valve, Hammer Union, Union Fittings and etc. | 2010~2016 |

PROJECT REFERENCE

| Company | Project Name | | Type | Scope of Supply |
|---|---|------------------------------|-------------|--|
|  Samsung Heavy Industries |  | SN 2059 ENSCO 78K | Semi-Rig | Hammer Union Hub Clamp Crossover |
| |  | SN 2097 STENA #1 | Semi-Rig | |
| |  | SN 2099 STATOIL MARINER | FSO | |
| | | SN 7117 / 7118 STATOIL CAT-J | Jack up-Rig | |
| |  | SN 7107 MAERSK #4 | Drill Ship | |
| |  | SN 7109 SEADRILL | Drill Ship | |
| | | SN 7119 / 7120 SEADRILL | Drill Ship | |
| |  | SN 7116 PACIFIC DRILLING | Drill Ship | |
| |  | SN 7111 SEATANKERS | Drill Ship | |
| |  | SN 7103 OCEAN RIG | Drill Ship | |

PROJECT REFERENCE

| Company | Project Name | | Type | Scope of Supply | | | | | | | | |
|--|---|-----------------------------|----------------|--|--|--|--|--|--|--|--|--|
|  DSME <small>DAEWOO SHIPBUILDING & MARINE ENGINEERING CO.,LTD.</small> DSME (Daewoo Shipbuilding & Marine Engineering) |  | P6056 STATOIL MARINER | Offshore Plant | Hammer Union Hub Clamp Crossover | | | | | | | | |
| |  | H3033 ODFJELL DRILLING | Semi-Rig | | | | | | | | | |
| |  | H3034/3035 SONGA CAT-D | Semi-Rig | | | | | | | | | |
| |  | H3305 MAERSK CJ70 | Jack up-Rig | | | | | | | | | |
| |  | H3507 TRANSOCEAN DEEPWATER | Drill Ship | | | | | | | | | |
| |  | H3511 TOD CHEVRON | Drill Ship | | | | | | | | | |
| |  | H3618 VANTAGE ENHANCED | Drill Ship | | | | | | | | | |
| |  | H3619/3622 ATWOOD PROJECT | Drill Ship | | | | | | | | | |
| |  | H3620/3621 SONANGOL PROJECT | Drill Ship | | | | | | | | | |
| |  | H3623/3624 SEADRILL | Drill Ship | | | | | | | | | |

PROJECT REFERENCE

| Company | | Project Name | Type | Scope of Supply |
|---|---|--|-------------------------|--|
| Hyundai Heavy Industries |  | 2704 OCEAN GREAT WHITE | Semi-Rig | Hammer Union Crossover |
| |  | HEBRON PROJECT | Offshore Plant | |
| Harrington Gen'l Trading |  | HO8046 DEEP CLEANER | Offshore service vessel | Plug Valve & Repair Kit, Swivel Joint, Pup Joint, Fittings |
| LUKOIL |  | WEST QURNA-2 PROJECT | Onshore Platform | Plug Valve, Swivel Joint, Pup Joint, Fittings |
| Australia Pacific LNG |  | TALINGA Upstream Phase 1 | Gas gathering Platform | Hammer Union |
| DANA Energy |  | RESHADAT OIL FIELD PROJECT | Cementing platform | Plug Valve & Repair Kit, Swivel Joint, Pup Joint, Fittings |
| NIDC (National Iranian Drilling Company) |  | SOUTH PARS PHASE 9 – 14 SOUTH AZADEGAN DRILLING PJT | Drilling Rig | Plug Valve & Repair Kit, Swivel Joint, Pup Joint, Steel Hose, Fittings |
| Others |  | Aker Solution/Brunei Shell Petroleum British Petroleum / Caspian Drilling | Various | Various |

GLOBAL SMI



CERTIFICATES



**API 6A -1064
Valves**



**API 16C -0134
Swivel joint**



**API 6D -0988
Ball Valve**



**API Specification
Q1**



**QMS
ISO9001:2008**



**EMS
ISO 14001:2004**

CERTIFICATES



**ABS
Manufacturing Assessment
for Pipe Fittings**



**ABS
Design Assessment
For Crossover 2F x 3F**



By National Iranian Drilling Company (NIDC)

FACILITIES



Machining Center (KH80G)



Machining Center (Hi-V50D)



Machining Center (Hi-V50D)



CNC Turning (ST850VD)



CNC Turning (VTB125E)



Machining Center (KH63G)

TEST / INSPECTION EQUIPMENTS



Pressure Test
Range:1000psi~22500psi



Pressure Test
Range:1000psi~22500psi



Brinell Hardness
HB : 11.5 ~ 945

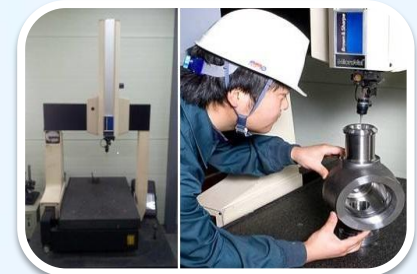

X-Y-Z Coordinate Measuring Machine



Illuminometer



Paint Film Gauge

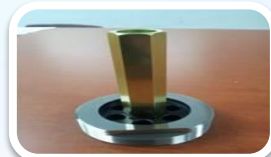

NPT Gauge

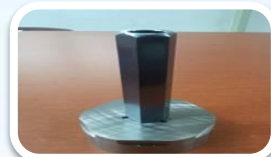

Taper Gauge



Micrometer

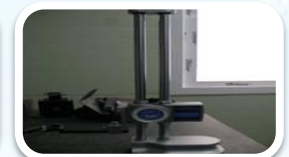

Height Gauge



Inside Micrometer



Cylinder Gauge



Block Gauge



Inside Micrometer



Dial Caliper

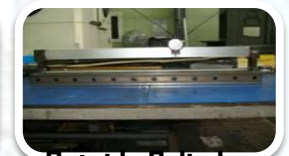

Outside Cylinder Gauge

EXHIBITION IN 2013/2014

- 2013.03.30~04.06 •Trade Mission to Islamic Republic of Iran
- 2013.06.05~06.07 •OGA Exhibition in Kuala Lumpur, Malaysia
- 2013.06.11~06.13 •Calgary Oil and Gas Expo in Alberta, Canada
- 2013.08.30~09.40 •2013 Korean Expo in Istanbul, Turkey
- 2013.11.10~11.13 •ADIPEC 2013 in Abu Dhabi, UAE
- 2013.11.13~11.15 •Oil & Gas Indonesia 2013 in Jakarta, Indonesia
- 2014.01.14~01.17 •Ahwaz Oil & Gas Exhibition, Iran
- 2014.02.16~02.20 •AOG 2014 in Perth, Australia
- 2014.03.24~03.27 •Gastech 2014 Korea
- 2014.05.02~05.13 •OTC 2014 in Houston, USA
- 2014.11.12~11.14 •KOMARINE 2014 in Pusan, Korea

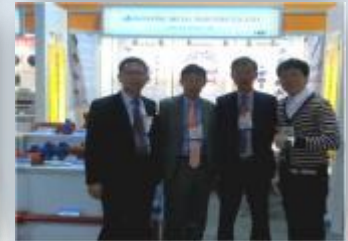

EXHIBITION IN 2015/2016

2015.03.18~03.20

•Vietnam INMEX 2015

2015.05.04~05.07

•OTC 2015 in Houston, USA

2015.06.02~06.05

•Norway Trade Fair in Oslo, Norway

2015.09.08~09.11

•Offshore Europe 2015 in Aberdeen, UK

2015.10.27~10.29

•TMOX 2015 in Bangkok, Thailand

2015.11.09~11.11

•ADIPEC 2015 in Abu Dhabi, UAE

2015.12.01~12.04

•Marintec China 2015 in Shanghai, China

2016.03.22~03.23

•OTC ASIA 2016 in Kuala Lumpur, Malaysia

2016.04.13~04.15

•Sea Japan 2016 in Tokyo, Japan

2016.05.02~05.05

•OTC 2016 in Houston, USA

2016.05.05~05.08

•Iran Oil Show in Tehran, Iran



WORK-SHOP & ANNUAL EVENT





The Perfect Value of SMI

SMI Co., Ltd.

24-25, 2saneopdanji 2-gil, Waegwan-eup, Chilgok-gun,
Gyeongsangbuk-do, 39910, Rep. of KOREA

Tel: +82-54-977-2250

Fax: +82-54-977-6900

Web: www.smi.co.kr

E-mail: smi@smi.co.kr